



NON METALLIC ENCLOSURES

# NON METALLIC ENCLOSURES



## INTRODUCTION

AR Corporation Limited is a Hong Kong based company established in 2005, manufactures AIBOX Non-metallic enclosures in modern production facility in mainland China.

AIBOX has a large range of non-metallic enclosures to cater needs of corrosion proof non-metallic enclosures and export to customers around the world.

AIBOX non-metallic enclosures come in different types and sizes to suit different applications in electrical installations. AIBOX can cater to requirements in solar installations, marine installations, corrosive environment and outdoor installation with it's large range of non-metallic enclosure models.

AIBOX non-metallic enclosures range has many advantages,

- Corrosion resistant – 100% safe to use in coastal environment & outdoor.
- Weather proof – can use in outdoor in any weather condition.
- Light weight – easy to handle & install.
- Double insulation gives perfect safety against direct & indirect contacts.
- Enclosures are homogeneous, no maintenance required.
- Fully insulated and body earthing is not required.
- Easy to do machining, drill holes and to modify.

AIBOX is a sophisticated non-metallic enclosure system with large range of sizes. These can be used as single units or as a combined system. AIBOX Combinable & Extendable (C&E) Enclosures can extendable in width & height directions to make electrical panel boards of any size on wall mounting.

Combinable & Extendable (C&E) Enclosure system can use for Low Voltage switchgear assemblies upto 630A, and are manufactured to IP66 of EN60529 standard. These can use for Distribution boards, Control panels and other low voltage assemblies.

AIBOX non-metallic enclosures can use for solar installations, factory automations, electronics, communications, telecommunication towers, surge suppressors, firefighting apparatus, terminal boxes, public utilities, maritime & ship industry, food industry and many other requirements.

**AIBOX non-metallic enclosure system trusted & used by customers around the world**

## CONTENTS

### PLASTIC ENCLOSURES

Plastic Enclosure - Plastic Screw - TJ Series - Grey Door & Clear Door .....	04
Plastic Enclosure - Plastic Screw - TJ Series - Grey Door & Clear Door .....	05
Plastic Enclosure - Plastic Screw - TJ Series - Grey Door .....	06
Plastic Enclosure - Plastic screw - TB series - Grey Door & Clear Door .....	07
Plastic Enclosure - Plastic Screw - with Rubber Grommets - TB Series - Grey Door & Clear Door .....	08
Plastic Enclosure - Stainless Steel Screws - TJ Series - Grey Door & Clear Door .....	09
Plastic Enclosure - with Plastic Hinge & Latch - MG Series - Grey Door & Clear Door .....	10
Plastic Enclosure - with Plastic Hinge & Lock - KG Series - Grey Door & Clear Door .....	10
Plastic Enclosure - with Steel Hinge & Latch - TG Series - Grey Door & Clear Door .....	11
Plastic Enclosure - with Steel Hinge & Latch - TE Series - Grey Door & Clear Door .....	12
Plastic Enclosure - with Stainless Steel Hinge & Latch - TJ Series - Grey Door & Clear Door .....	13 - 14
Plastic Enclosure - with Stainless Steel Hinge & Latch - TE Series - Grey Door & Clear Door .....	15
Plastic Enclosure - Corner Hinge & Plastic Screw - TJ Series - Grey Door & Clear Door .....	16
Plastic Enclosure - Angled cover - Plastic Screw (Black) - PIS Series - Grey Door & Clear Door .....	16

### POLYESTER ENCLOSURES

Polyester Enclosures - with door - TIP Series - Grey Door & Glass Door .....	18
Mounting Plate - for Polyester Enclosures - Polyester MP & Galvaized steel MP .....	19
Inner Door - for Polyester Enclosures .....	19
DIN Rails Kit - for Polyester Enclosures .....	19
Accessories - for Polyester Enclosures .....	19
Accessories - for Polyester Enclosures - PSM Series - Grey Door .....	20
Polyester Enclosures - with Screws - PSG & PST Series - Grey Door & Clear Door .....	20

### GRP (GLASS REINFORCED PLASTICS) ENCLOSURES

GRP Enclosures - Free Standing .....	22
--------------------------------------	----



## Plastic Enclosures



**PLASTIC ENCLOSURE - PLASTIC SCREW**

**Plastic Enclosure - Plastic screw - TJ series - Grey Door & Clear Door**

AIBOX non-metallic enclosures are corrosion proof and can use for many applications where non-metallic enclosures are required

Weight of non-metallic enclosures is 25% of the weight of steel enclosures and can use for similar applications where non-metallic enclosures are preferred. Non-metallic enclosures are having good insulation properties and light weight and give advantages over steel enclosures in some applications.

Plastic Enclosure - Plastic screw - TJ series - Grey Door & Clear Door comes with plastic screws and available in grey solid door or transparent door

Temperature range : -40°C to 120°C

ABS : Acrylonitrile Butadiene styrene

PC: Poly Carbonate

Screw Type		Dimension (mm)		Mounting Plate		Installation size (mm)	
Grey door	Clear door	W X H X XD	D1 + D2	Plastic	Metal	W3	H3
TJ-AG-0609	TJ-AT-0609	65 X 95 X 55	40 + 15	-	-	50	79
TJ-AG-0710	TJ-AT-0710	75 X 105 X 60	40 + 20	-	TJ-0710	57	86
TJ-AG-0712	TJ-AT-0712	75 X 125 X 75	49 + 25	TJ-0712P	TJ-0712	57	107
TJ-AG-0712 - 1	TJ-AT-0712 - 1	75 X 125 X 100	49 + 50	TJ-0712P	TJ-0712	57	107
TJ-AG-0808	TJ-AT-0808	80 X 80 X 60	45 + 15	TJ-0808P	TJ-0808	62	62
TJ-AG-0808 - 1	TJ-AT-0808 - 1	80 X 80 X 85	70 + 15	TJ-0808P	TJ-0808	62	62
TJ-AG-0811 - 5	TJ-AT-0811 - 5	80 X 110 X 45	25 + 20	TJ-0811P	TJ-0811	62	92
TJ-AG-0811 - 15	TJ-AT-0811 - 15	80 X 110 X 65	25 + 35	TJ-0811P	TJ-0811	62	92
TJ-AG-0811	TJ-AT-0811	80 X 110 X 70	50 + 20	TJ-0811P	TJ-0811	62	92
TJ-AG-0811 - 1	TJ-AT-0811 - 1	80 X 110 X 85	50 + 35	TJ-0811P	TJ-0811	62	92
TJ-AG-0811 - 2	TJ-AT-0811 - 2	80 X 110 X 100	80 + 20	TJ-0811P	TJ-0811	62	92
TJ-AG-0811 - 3	TJ-AT-0811 - 3	80 X 110 X 115	80 + 35	TJ-0811P	TJ-0811	62	92
TJ-AG-0813	TJ-AT-0813	80 X 130 X 70	50 + 20	TJ-0813P	TJ-0813	62	112
TJ-AG-0813 - 1	TJ-AT-0813 - 1	80 X 130 X 85	50 + 35	TJ-0813P	TJ-0813	62	112
TJ-AG-0818	TJ-AT-0818	80 X 180 X 70	50 + 20	TJ-0818P	TJ-0818	62	162
TJ-AG-0818 - 1	TJ-AT-0818 - 1	80 X 180 X 85	50 + 35	TJ-0818P	TJ-0818	62	162
TJ-AG-0822	TJ-AT-0822	80 X 220 X 70	50 + 20	-	TJ-0822	62	202
TJ-AG-0825	TJ-AT-0825	80 X 250 X 70	50 + 20	TJ-0825P	TJ-0825	62	232
TJ-AG-0825 - 1	TJ-AT-0825 - 1	80 X 250 X 85	50 + 35	TJ-0825P	TJ-0825	62	232
TJ-AG-0825 - 2	TJ-AT-0825 - 2	80 X 250 X 100	50 + 50	TJ-0825P	TJ-0825	62	232
TJ-AG-0913	TJ-AT-0913	94 X 130 X 70	50 + 20	-	TJ-0913	74	115
TJ-AG-0913 - 1	TJ-AT-0913 - 1	94 X 130 X 100	80 + 20	-	TJ-0913	74	115
TJ-AG-1010	TJ-AT-1010	100 X 100 X 75	55 + 20	TJ-1010P	TJ-1010	82	82
TJ-AG-1010 - 1	TJ-AT-1010 - 1	100 X 100 X 100	80 + 20	TJ-1010P	TJ-1010	82	82
TJ-AG-1022	TJ-AT-1022	100 X 224 X 75	60 + 15	-	TJ-1022	76	198
TJ-AG-1018	TJ-AT-1018	100 X 180 X 75	60 + 15	-	TJ-1018	76	155
TJ-AG-1118	TJ-AT-1118	113 X 183 X 90	70 + 20	TJ-1118P	TJ-1118	95	165
TJ-AG-1118 - 1	TJ-AT-1118 - 1	113 X 183 X 105	70 + 35	TJ-1118P	TJ-1118	95	165
TJ-AG-1216	TJ-AT-1216	120 X 160 X 90	70 + 20	-	TJ-1216	102	142
TJ-AG-1220	TJ-AT-1220	120 X 200 X 75	55 + 20	TJ-1220P	TJ-1220	102	182
TJ-AG-1222	TJ-AT-1222	120 X 220 X 85	67 + 20	TJ-1222P	TJ-1222	100	200
TJ-AG-1212 - S	TJ-AT-1212 - S	125 X 125 X 75	55 + 20	TJ-1212P	TJ-1212	105	105
TJ-AG-1212	TJ-AT-1212	125 X 125 X 100	80 + 20	TJ-1212P	TJ-1212	105	105
TJ-AG-1217	TJ-AT-1217	125 X 175 X 75	50 + 25	TJ-1217P	TJ-1217	109	156
TJ-AG-1217 - 1	TJ-AT-1217 - 1	125 X 175 X 100	50 + 50	TJ-1217P	TJ-1217	109	156
TJ-AG-1217 - 2	TJ-AT-1217 - 2	125 X 175 X 110	85 + 25	TJ-1217P	TJ-1217	109	156
TJ-AG-1217 - 3	TJ-AT-1217 - 3	125 X 175 X 135	85 + 50	TJ-1217P	TJ-1217	109	156
TJ-AG-1417	TJ-AT-1417	140 X 170 X 95	75 + 20	TJ-1417P	TJ-1417	122	152
TJ-AG-1423	TJ-AT-1423	140 X 230 X 95	75 + 20	TJ-1423P	TJ-1423	122	212
TJ-AG-1520 - S	TJ-AT-1520 - S	150 X 200 X 75	55 + 20	TJ-1520P	TJ-1520	132	182
TJ-AG-1520	TJ-AT-1520	150 X 200 X 100	80 + 20	TJ-1520P	TJ-1520	132	182
TJ-AG-1520 - 1	TJ-AT-1520 - 1	150 X 200 X 130	80 + 50	TJ-1520P	TJ-1520	132	182
TJ-AG-1520 - 2	TJ-AT-1520 - 2	150 X 200 X 130	110 + 20	TJ-1520P	TJ-1520	132	182
TJ-AG-1520 - 3	TJ-AT-1520 - 3	150 X 200 X 160	110 + 50	TJ-1520P	TJ-1520	132	182
TJ-AG-1525	TJ-AT-1525	150 X 250 X 100	80 + 20	TJ-1525P	TJ-1525	132	232
TJ-AG-1525 - 1	TJ-AT-1525 - 1	150 X 250 X 130	80 + 50	TJ-1525P	TJ-1525	132	232
TJ-AG-1525 - 2	TJ-AT-1525 - 2	150 X 250 X 130	110 + 20	TJ-1525P	TJ-1525	132	232
TJ-AG-1525 - 3	TJ-AT-1525 - 3	150 X 250 X 160	110 + 50	TJ-1525P	TJ-1525	132	232
TJ-AG-1717	TJ-AT-1717	175 X 175 X 75	50 + 25	TJ-1717P	TJ-1717	156	157
TJ-AG-1717 - 1	TJ-AT-1717 - 1	175 X 175 X 100	50 + 50	TJ-1717P	TJ-1717	156	157
TJ-AG-1717 - 2	TJ-AT-1717 - 2	175 X 175 X 125	100 + 25	TJ-1717P	TJ-1717	156	157
TJ-AG-1717 - 3	TJ-AT-1717 - 3	175 X 175 X 150	100 + 50	TJ-1717P	TJ-1717	156	157
TJ-AG-1725	TJ-AT-1725	175 X 250 X 75	50 + 25	TJ-1725P	TJ-1725	156	232
TJ-AG-1725 - 1	TJ-AT-1725 - 1	175 X 250 X 100	50 + 50	TJ-1725P	TJ-1725	156	232
TJ-AG-1825	TJ-AT-1825	180 X 255 X 100	85 + 15	-	TJ-1825	162	236
TJ-AG-2020 - S	TJ-AT-2020 - S	200 X 200 X 95	75 + 20	TJ-2020P	TJ-2020	182	182
TJ-AG-2020 - 1	TJ-AT-2020 - 1	200 X 200 X 125	75 + 50	TJ-2020P	TJ-2020	182	182
TJ-AG-2020	TJ-AT-2020	200 X 200 X 130	110 + 20	TJ-2020P	TJ-2020	182	182
TJ-AG-2020 - 2	TJ-AT-2020 - 2	200 X 200 X 160	110 + 20	TJ-2020P	TJ-2020	182	182
TJ-AG-2025	TJ-AT-2025	200 X 250 X 100	75 + 25	TJ-2025P	TJ-2025	178	228
TJ-AG-2030	TJ-AT-2030	200 X 300 X 105	85 + 50	TJ-2030P	TJ-2030	180	280

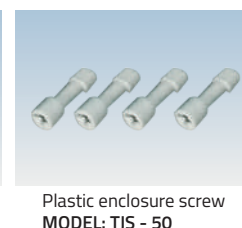
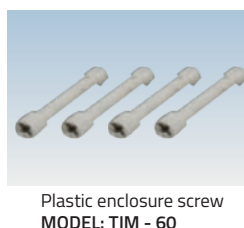
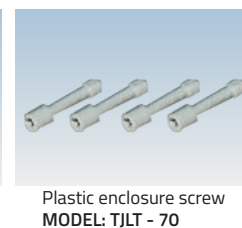
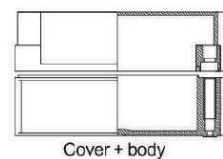
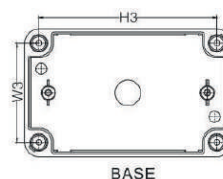

**PLASTIC ENCLOSURE**

**Plastic Enclosure - Plastic screw - TJ series - Grey Door & Clear Door**

AIBOX non-metallic enclosures are corrosion proof and can use for many applications where non-metallic enclosures are required

Weight of non-metallic enclosures is 25% of the weight of steel enclosures and can use for similar applications where non-metallic enclosures are preferred. Non-metallic enclosures are having good insulation properties and light weight and give advantages over steel enclosures in some applications.

Plastic Enclosure - Plastic screw - TJ series - Grey Door & Clear Door comes with plastic screws and available in grey solid door or transparent door

Temperature range : -40°C to 120°C  
 ABS : Acrulonitrile Butadiene styrene  
 PC: Poly Carbonate

Screw Type		Dimension (mm)		Mounting Plate		Installation size (mm)	
Grey door	Clear door	W X H X XD	D1 + D2	Plastic	Metal	W3	H3
TJ-AG-2819	TJ-AT-2819	280 X 190 X 130	98 + 32	TJ-2819P	TJ-2819	255	165
TJ-AG-2819 - 1	TJ-AT-2819 - 1	280 X 190 X 180	98 + 82	TJ-2819P	TJ-2819	255	165
TJ-AG-2819 - 2	TJ-AT-2819 - 2	280 X 190 X 180	148 + 32	TJ-2819P	TJ-2819	255	165
TJ-AG-2819 - 3	TJ-AT-2819 - 3	280 X 190 X 230	148 + 82	TJ-2819P	TJ-2819	255	165
TJ-AG-2828	TJ-AT-2828	280 X 280 X 130	98 + 32	TJ-2828P	TJ-2828	255	255
TJ-AG-2828 - 1	TJ-AT-2828 - 1	280 X 280 X 180	98 + 81	TJ-2828P	TJ-2828	255	255
TJ-AG-2828 - 2	TJ-AT-2828 - 2	280 X 280 X 180	148 + 32	TJ-2828P	TJ-2828	255	255
TJ-AG-2828 - 3	TJ-AT-2828 - 3	280 X 280 X 230	148 + 81	TJ-2828P	TJ-2828	255	255
TJ-AG-3428	TJ-AT-3428	340 X 280 X 130	98 + 32	TJ-3428P	TJ-3428	315	255
TJ-AG-3428 - 1	TJ-AT-3428 - 1	340 X 280 X 180	98 + 81	TJ-3428P	TJ-3428	355	355
TJ-AG-3819- S	TJ-AT-3819- S	380 X 190 X 100	69+ 30	TJ-3819P	TJ-3819	355	165
TJ-AG-3819	TJ-AT-3819	380 X 190 X 130	98 + 30	TJ-3819P	TJ-3819	355	165
TJ-AG-3819 - 1	TJ-AT-3819 - 1	380 X 190 X 180	148 + 30	TJ-3819P	TJ-3819	355	165
TJ-AG-3828	TJ-AT-3828	380 X 280 X 130	98 + 32	TJ-3828P	TJ-3828	355	255
TJ-AG-3828 - 1	TJ-AT-3828 - 1	380 X 280 X 180	98+ 82	TJ-3828P	TJ-3828	355	255
TJ-AG-3828 - 2	TJ-AT-3828 - 2	380 X 280 X 180	148 + 32	TJ-3828P	TJ-3828	355	255
TJ-AG-3828 - 3	TJ-AT-3828 - 3	380 X 280 X 230	148 + 82	TJ-3828P	TJ-3828	355	255
TJ-AG-2856	TJ-AT-2856	280 X 560X 130	98 + 32	TJ-2828P x 2	TJ-2856	540	255
TJ-AG-3856	TJ-AT-3856	380 X 560X 180	148 + 32	TJ-3828P x 2	TJ-3856	534	354

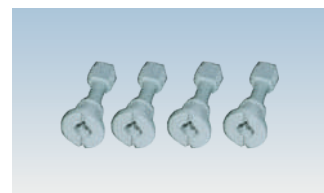
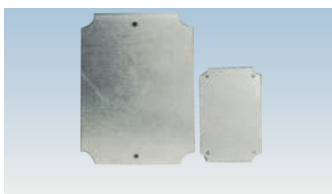
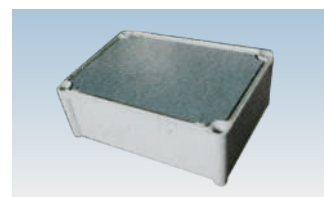
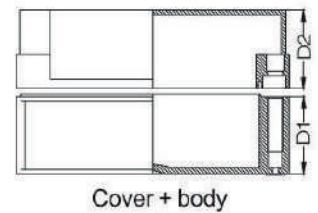
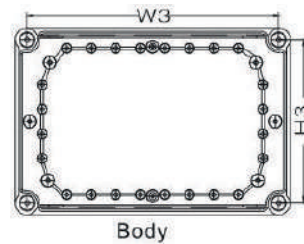
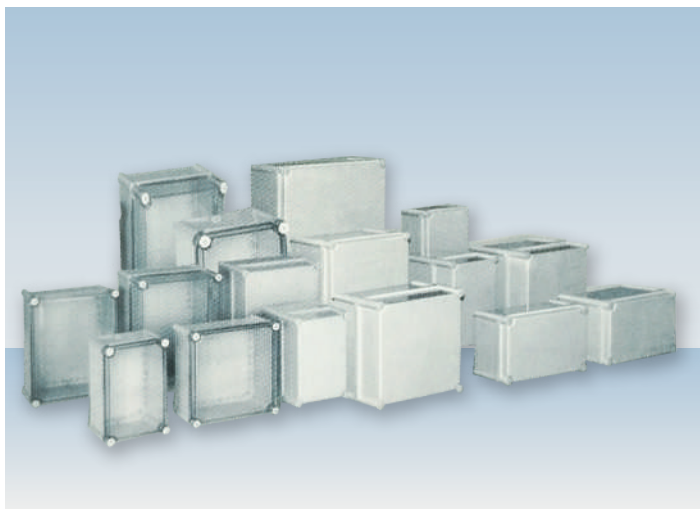

**PLASTIC ENCLOSURE**

**Plastic Enclosure - Plastic screw - TJ series - Grey Door**

AIBOX non-metallic enclosures are corrosion proof and can use for many applications where non-metallic enclosures are required

Weight of non-metallic enclosures is 25% of the weight of steel enclosures and can use for similar applications where non-metallic enclosures are preferred. Non-metallic enclosures are having good insulation properties and light weight and give advantages over steel enclosures in some applications.

Plastic Enclosure - Plastic screw - TJ series - Grey Door comes with plastic screws and available in grey solid door

High strength ABS material give better robust in usage

Screw Type	Size (mm)	Dimension (mm)				Plate Model	Plate size	
		W1	H1	D1	D2		M1	M2
Grey door	W X H X XD							
TJ-AG-2234	220 X 340 X 145	314	194	40	105	TJ-2234	198	318
TJ-AG-2730	270 X 300 X 145	274	244	40	105	TJ-2730	245	275
TJ-AG-3040	300 X 400 X 160	374	274	55	105	TJ-3040	275	375
TJ-AG-2746	270 X 460 X 160	434	244	55	105	TJ-2746	245	435
TJ-AG-3052	300 X 520 X 160	494	274	55	105	TJ-3052	275	495
TJ-AG-3654	360 X 540 X 180	514	334	55	125	TJ-3654	333	513

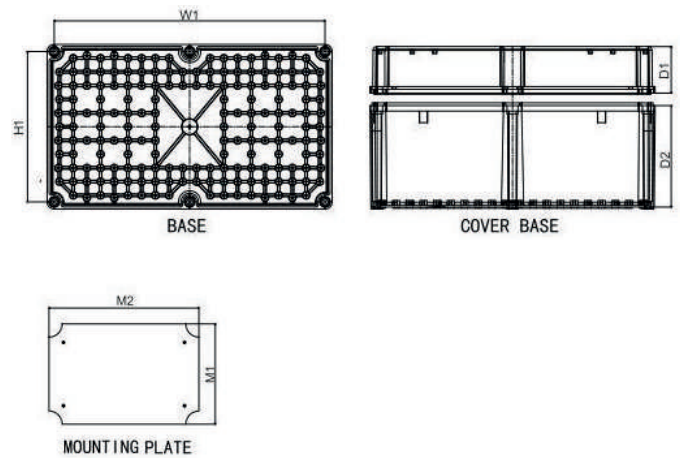

**Accessories**

**Inside hinge**

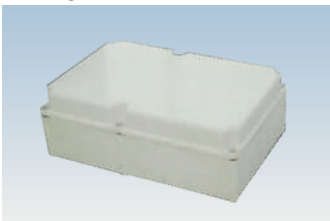

**Upright post fixing**

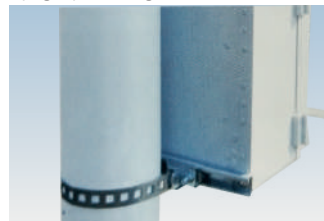

**Installing rail**



**Wall mount bracket**

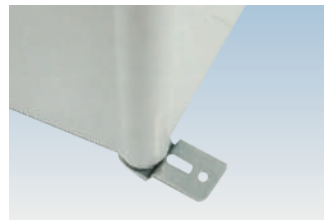

**PLASTIC ENCLOSURE**

**Plastic Enclosure - Plastic screw - TB series - Grey Door & Clear Door**

AIBOX non-metallic enclosures are corrosion proof and can use for many applications where non-metallic enclosures are required

Weight of non-metallic enclosures is 25% of the weight of steel enclosures and can use for similar applications where non-metallic enclosures are preferred. Non-metallic enclosures are having good insulation properties and light weight and give advantages over steel enclosures in some applications.

Plastic Enclosure - Plastic screw - TB series - Grey Door & Clear Door comes with plastic screws and available in grey solid door or transparent door

The products prevent electromagnetic interference (EMI) and prevent substances of the static electricity,

Temperature range : -40°C to 120°C  
 ABS : Acrulonitrile Butadiene styrene  
 PC: Poly Carbonate

Plastic Screw Type		Dimension (mm)		Mounting Plate	Installation size (mm)	
Grey door	Clear door	W X H X XD	D1 + D2	Metal	W3	H3
TB-AG-0711	TB-AT-0711	78 X 113 X 55	43 + 15	TJ-0711	73.5	108.5
TB-AG-0812	TB-AT-0812	80 X 120 X 54	43 + 15	TJ-0812	83	124
TB-AG-1010	TB-AT-1010	100 X 100 X 54	43 + 15	TJ-1010	104	104
TB-AG-1020	TB-AT-1020	100 X 200 X 70	57 + 15	TJ-1020	104.5	204
TB-AG-1115	TB-AT-1115	110 X 150 X 72	52 + 24	TJ-1115	113	153
TB-AG-1419	TB-AT-1419	140 X 190 X 76	54 + 25	TJ-1419	144	194
TB-AG-1515	TB-AT-1515	150 X 150 X 70	57 + 15	TJ-1515	154.5	154.5
TB-AG-1924	TB-AT-1924	190 X 240 X 95	70 + 28	TJ-1924	195	250
TB-AG-1924 - 1	TB-AT-1924 - 1	190 X 240 X 165	70 + 98	TJ-1924	195	250
TB-AG-2230	TB-AT-2230	220 X 300 X 125	79 + 50	TJ-2230	230	310
TB-AG-2230 - 1	TB-AT-2230 - 1	220 X 300 X 185	79 + 110	TJ-2230	220	300
TB-AG-3038	TB-AT-3038	300 X 380 X 125	78 + 50	TJ-3038	310	390
TB-AG-3038 - 1	TB-AT-3038 - 1	300 X 380 X 185	78 + 110	TJ-3038	310	390

Size TBAG0812-TBAG1115 metal screw

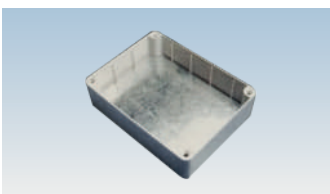
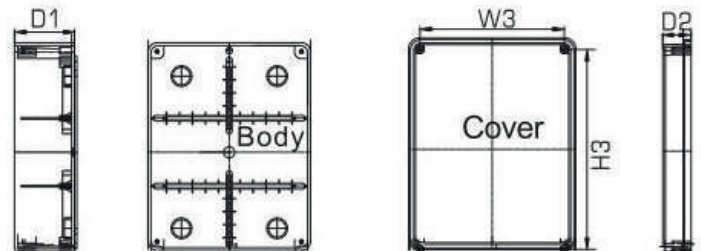
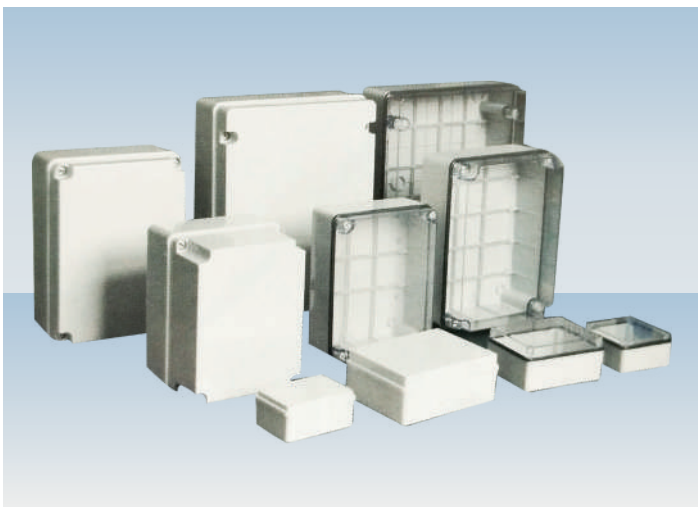

Metal mounting plate



Size TBAG1419-TBAG3038-1  
Plastic screw



Cover open at 90 degree  
Size TBAG1419-TBAG3038-1  
Plastic screw



Wall bracket  
Model: TB-05 for (TB-AG-1419)



Wall bracket  
Model: TB-06  
for (TB-AG-1924 -TB-AG-3038-1)

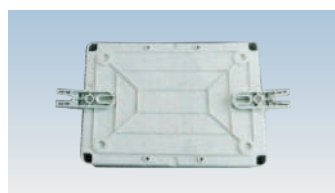

Wall bracket



**PLASTIC ENCLOSURE**

**Plastic Enclosure - Plastic Screw - with Rubber Grommets - TB Series - Grey Door & Clear Door**

AIBOX non-metallic enclosures are corrosion proof and can use for many applications where non-metallic enclosures are required

Weight of non-metallic enclosures is 25% of the weight of steel enclosures and can use for similar applications where non-metallic enclosures are preferred. Non-metallic enclosures are having good insulation properties and light weight and give advantages over steel enclosures in some applications.

Plastic Enclosure - Plastic screw - with Rubber Grommets - TB series - Grey Door & Clear Door comes with plastic screws and available in grey solid door or transparent door

Inbuilt rubber grommets facilitates cable in and out with required IP ratings

Plastic Screw Type + knock out type		Dimension (mm)		Mounting Plate	Installation size (mm)		
Grey door	Clear door	W X H X XD	D1 + D2	Metal	W3	H3	Holes
TB-AG-C60R	TB-AT-C60R	∅ 60 X 45	-	-	-	-	4
TB-AG-C70R	TB-AT-C70R	∅ 70 X 48	-	-	-	-	4
TB-AG-0606R	TB-AT-0606R	75 X 75 X 45	41.7 + 10	-	-	-	7
TB-AG-0808R	TB-AT-0808R	89 X 89 X 50	46.5 + 10	-	-	-	7
TB-AG-0812R	TB-AT-0812R	80 X 120 X 54	43 + 14	TJ-0812	88	88	6
TB-AG-1010R	TB-AT-1010R	100 X 100 X 54	43 + 14	TJ-1010	68	108	6
TB-AG-1115R	TB-AT-1115R	110 X 150 X 72	52 + 25	TJ-1115	98	137	10
TB-AG-1419R	TB-AT-1419R	140 X 190 X 76	54 + 25	TJ-1419	128	177	10
TB-AG-1924R	TB-AT-1924R	190 X 240 X 95	70 + 25	TJ-1924	170	226	12
TB-AG-1924 - 1R	TB-AT-1924 - 1R	190 X 240 X 165	70 + 96	TJ-1924	170	226	12
TB-AG-2230R	TB-AT-2230R	220 X 300 X 125	76 + 50	TJ-2230	200	280	12
TB-AG-2230 - 1R	TB-AT-2230 - 1R	220 X 300 X 185	76 + 96	TJ-2230	200	280	12
TB-AG-3038R	TB-AT-3038R	300 X 380 X 125	78 + 50	TJ-3038	281	278	12
TB-AG-3038R - 1R	TB-AT-3038R - 1R	300 X 380 X 185	78 + 110	TJ-1038	281	278	12

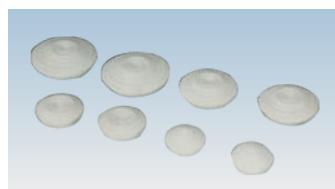
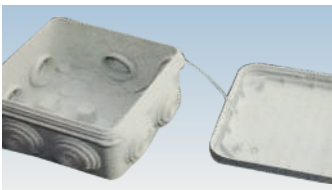
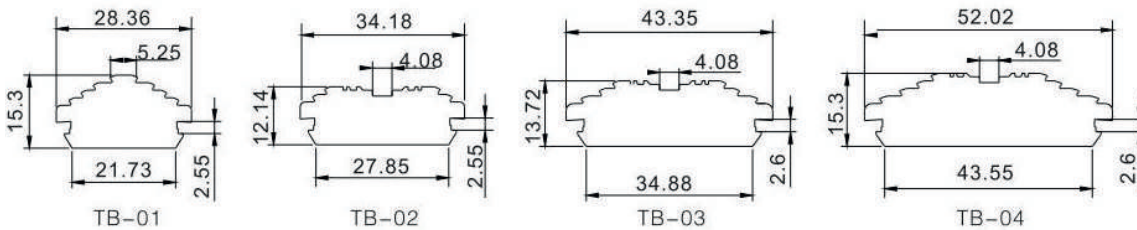
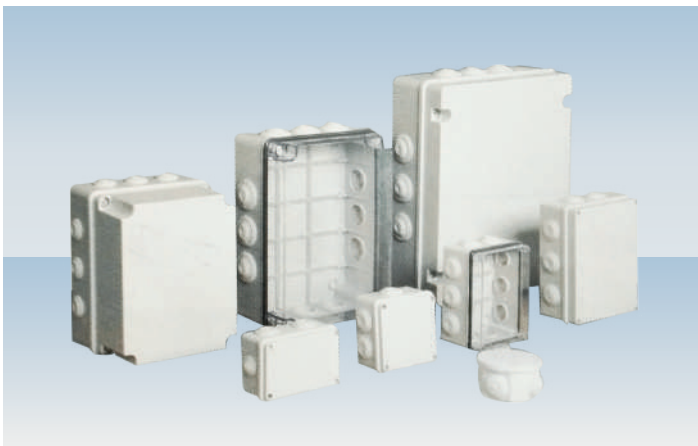

rubber sealing

**PLASTIC ENCLOSURE**

**Plastic Enclosure - Stainless Steel Screws - TJ series - Grey Door & Clear Door**

AIBOX non-metallic enclosures are corrosion proof and can use for many applications where non-metallic enclosures are required

Weight of non-metallic enclosures is 25% of the weight of steel enclosures and can use for similar applications where non-metallic enclosures are preferred. Non-metallic enclosures are having good insulation properties and light weight and give advantages over steel enclosures in some applications.

Plastic Enclosure - Stainless Steel Screws - TJ series - Grey Door & Clear Door comes with stainless steel screws and available in grey solid door or transparent door

Temperature range : -40°C to 120°C  
 ABS : Acrylonitrile Butadiene styrene  
 PC: Poly Carbonate

Screw Type		Dimension (mm)		Mounting Plate		Installation size (mm)	
Grey door	Clear door	W X H X XD	D1 + D2	Plastic	Metal	W3	H3
TJ-AG-0506	TJ-AT-0506	50 X 65 X 55	35 + 20	-	TJ-0506	37	52
TJ-AG-0507	TJ-AT-0507	55 X 70 X 43	35 + 8	-	TJ-0507	47	52
TJ-AG-0509	TJ-AT-0509	55 X 91 X 43	35 + 8	-	TJ-0509	47	78
TJ-AG-0709	TJ-AT-0709	75 X 91 X 43	35 + 8	-	-	67	78
TJ-AG-0712 - S	TJ-AT-0712 - S	75 X 125 X 48	40 + 8	-	TJ-0712	61	114
TJ-AG-0816 - S	TJ-AT-0816 - S	80 X 160 X 55	40 + 15	TJ-0816P	TJ-0816	68	148
TJ-AG-0816	TJ-AT-0816	80 X 160 X 90	75 + 15	TJ-0816P	TJ-0816	68	148
TJ-AG-0910	TJ-AT-0910	90 X 110 X 43	35 + 8	-	TJ-0910	78	102
TJ-AG-0912	TJ-AT-0912	90 X 125 X 48	40 + 8	-	TJ-0912	81	114

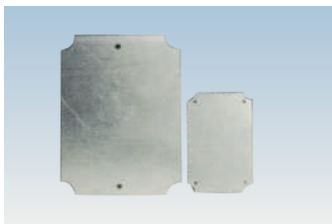
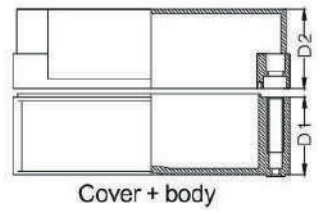
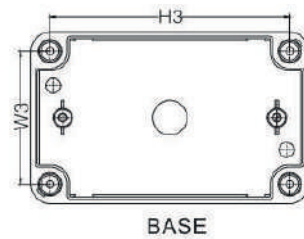

Steel mounting plate

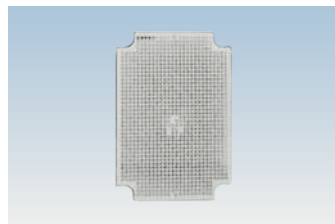

Plastic mounting plate



Wall brackets for Plastic Box  
 MODEL: WP - 01

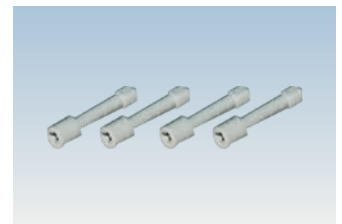

Plastic enclosure screw  
 MODEL: TJLT - 70

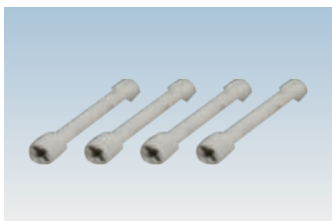

Plastic enclosure screw  
 MODEL: TJM - 60

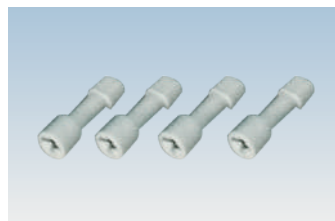

Plastic enclosure screw  
 MODEL: TJS - 50

**PLASTIC ENCLOSURE**

**Plastic Enclosure - MG & KG series - Grey Door & Clear Door**

AIBOX non-metallic enclosures are corrosion proof and can use for many applications where non-metallic enclosures are required

Weight of non-metallic enclosures is 25% of the weight of steel enclosures and can use for similar applications where non-metallic enclosures are preferred. Non-metallic enclosures are having good insulation properties and light weight and give advantages over steel enclosures in some applications.

Plastic Enclosure - with Plastic Hinge & Latch - MG series - Grey Door & Clear Door, comes with plastic hinge & latch and available in grey solid door or transparent door

Plastic Enclosure - with Plastic Hinge & Lock - KG series - Grey Door & Clear Door; comes with plastic hinge & lock and available in grey solid door or transparent door

High strength ABS, PC refractories and UV added material, makes the enclosure is suitable for external rugged environments.

Temperature range : -40°C to 120°C

ABS : Acrylonitrile Butadiene styrene

PC: Poly Carbonate

**Plastic Enclosure - with Plastic Hinge & Latch - MG series - Grey Door & Clear Door**

Plastic latch + hinge type		Dimension (mm)		Mounting Plate		Installation size (mm)	
Grey door	Clear door	W X H X XD	D1 + D2	Plastic	Metal	W3	H3
TJ-MG-2030	TJ-MT-2030	200 X 300 X 180	130 + 50	TJ-2030P	TJ-2030	270	170
TJ-MG-3030	TJ-MT-3030	300 X 300 X 180	130+ 50	TJ-3030P	TJ-3030	270	270
TJ-MG-3040	TJ-MT-3040	300 X 400 X 180	130 + 50	TJ-3040P	TJ-3040	370	270
TJ-MG-3040 - 1	TJ-MT-3040 - 1	300 X 400 X 210	160 + 50	TJ-3040P	TJ-3040	370	270
TJ-MG-4050	TJ-MT-4050	400 X 500 X 200	150 + 50	TJ-4050P	TJ-4050	470	270
TJ-MG-4060	TJ-MT-4060	400 X 600 X 220	170 + 50	TJ-3040P x2	TJ-4060	570	370



Hinges for fixing inner door - MODEL: WG-02

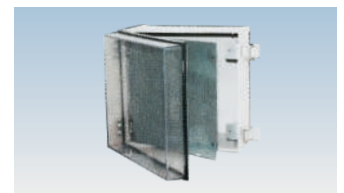

Fixed with inner plate

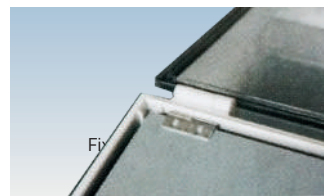

**Plastic Enclosure - with Plastic Hinge & Lock - KG series - Grey Door & Clear Door**

Lock Type		Dimension (mm)		Mounting Plate		Installation size (mm)	
Grey door	Clear door	W X H X XD	D1 + D2	Plastic	Metal	W3	H3
TJ-KG-2030	TJ-KT-2030	200 X 300 X 180	130 + 50	TJ-2030P	TJ-2030	270	170
TJ-KG-3030	TJ-KT-3030	300 X 300 X 180	130+ 50	TJ-3030P	TJ-3030	270	270
TJ-KG-3040	TJ-KT-3040	300 X 400 X 180	130 + 50	TJ-3040P	TJ-3040	370	270
TJ-KG-3040 - 1	TJ-KT-3040 - 1	300 X 400 X 210	160 + 50	TJ-3040P	TJ-3040	370	270
TJ-KG-4050	TJ-KT-4050	400 X 500 X 200	150 + 50	TJ-4050P	TJ-4050	470	270
TJ-KG-4060	TJ-KT-4060	400 X 600 X 220	170 + 50	TJ-3040PX2	TJ-4060	570	370

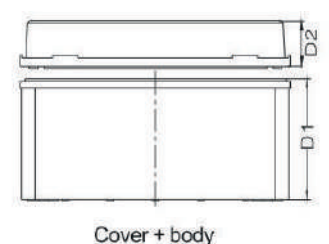
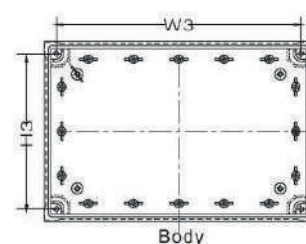

**PLASTIC ENCLOSURE**

**Plastic Enclosure - with Steel Hinge & Latch - TG Series - Grey Door & Clear Door**

AIBOX non-metallic enclosures are corrosion proof and can use for many applications where non-metallic enclosures are required

Weight of non-metallic enclosures is 25% of the weight of steel enclosures and can use for similar applications where non-metallic enclosures are preferred. Non-metallic enclosures are having good insulation properties and light weight and give advantages over steel enclosures in some applications.

Plastic Enclosure - with Steel Hinge & Latch - TG series - Grey Door & Clear Door, comes with steel hinge & steel latch and available in grey solid door or transparent door

Plastic latch + hinge type		Dimension (mm)		Mounting Plate		Installation size (mm)	
Grey door	Clear door	W X H X XD	D1 + D2	Plastic	Metal	W3	H3
TJ-MG-2227T	TJ-MT-2227T	225 X 275 X 120	100 + 20	-	TJ-2227	238	188
TJ-MG-2030-ST	TJ-MT-2030-ST	200 X 300 X 150	120+ 30	TJ-2030P	TJ-2030	268	168
TJ-MG-2030T	TJ-MT-2030T	200 X 300 X 180	130 + 50	TJ-2030P	TJ-2030	270	170
TJ-MG-3030T	TJ-MT-3030T	300 X 300 X 180	130 + 50	TJ-3030P	TJ-3030	270	270
TJ-MG-3040T	TJ-MT-3040T	300 X 400 X 180	130 + 50	TJ-3040P	TJ-3040	370	270
TJ-MG-3040-1T	TJ-MT-3040-1T	300 X 400 X 210	160 + 50	TJ-3040P	TJ-3040	370	270
TJ-MG-4050T	TJ-MT-4050T	400 X 500 X 200	150 + 50	TJ-4050P	TJ-4050	470	270
TJ-MG-4060T	TJ-MT-4060T	400 X 600 X 220	170 + 50	TJ-3040PX2	TJ-4060	570	370

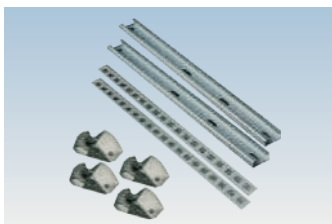

Hoop(telegraph pole fixing)  
MODEL: BG 080



Fixed on the telegraph pole

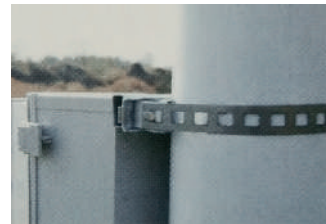

Fixed on the telegraph pole

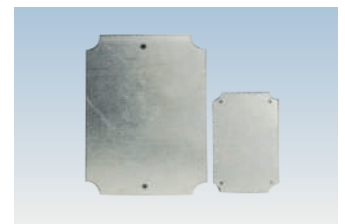

Steel mounting plate

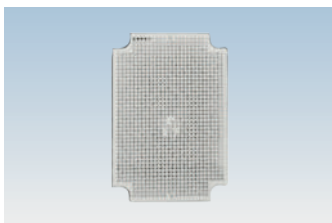

Plastic mounting plate



Wall Brackets for big plastic box  
MODEL: MG



Stainless steel hinge  
MODEL: HG-02



Stainless steel latch  
MODEL: LC-02



Plastic hinge for box MG,KG  
MODEL: PH-01



Plastic hinge for box MG  
MODEL: PL-01

**PLASTIC ENCLOSURE**

**Plastic Enclosure - with Steel Hinge & Latch - TE Series - Grey Door & Clear Door**

AIBOX non-metallic enclosures are corrosion proof and can use for many applications where non-metallic enclosures are required

Weight of non-metallic enclosures is 25% of the weight of steel enclosures and can use for similar applications where non-metallic enclosures are preferred. Non-metallic enclosures are having good insulation properties and light weight and give advantages over steel enclosures in some applications.

Plastic Enclosure - with Steel Hinge & Latch - TE series - Grey Door & Clear Door comes with steel hinge & steel latch and available in grey solid door or transparent door

Metal latch + hinge type		Dimension (mm)		Mounting Plate
Grey door	Clear door	W X H X D	D1 + D2	Metal
TE-AG-5363-S	TE-AT-5363-S	530 X 630 X 185	150 + 35	TJ-5363
TE-AG-5363	TE-AT-5363	530 X 630 X 255	220+ 35	TJ-5363
TE-AG-5373-S	TE-AT-5373-S	530 X 730 X 185	150 + 35	TJ-5373
TE-AG-5373	TE-AT-5373	530 X 730 X 255	220 + 35	TJ-5373
TE-AG-6383-S	TE-AT-6383-S	630 X 830 X 185	150 + 35	TJ-6383
TE-AG-6383	TE-AT-6383	630 X 830 X 285	220 + 35	TJ-6383

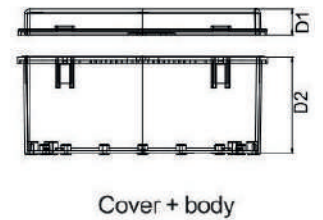
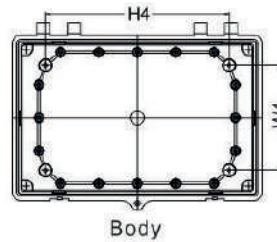

Metall latch



hinge

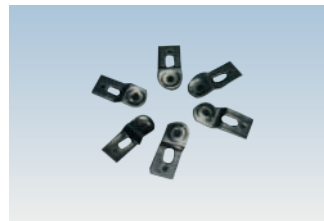

wall brackets model: WP-02

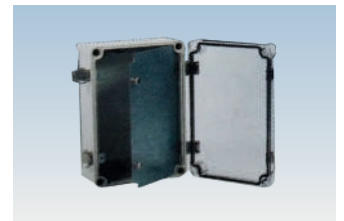

for box  
TE-2530A TE-2530B TE-2535A  
TE-2535B TE-1929A TE-2939A  
TE-2939B TE-3030A TE-3030B  
TE-3346A TE-3546A

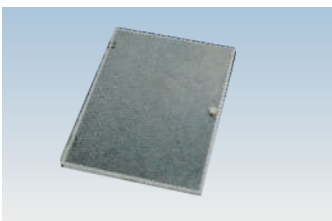

Material:2mm thickness  
Aluminum inner door or  
galvanized plate 1.5mm

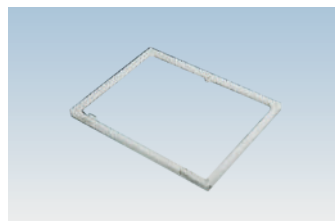

Plastic frame for inner door

**PLASTIC ENCLOSURE**

**Plastic Enclosure - with Stainless Steel Hinge & Latch - TJ Series - Grey Door & Clear Door**

AIBOX non-metallic enclosures are corrosion proof and can use for many applications where non-metallic enclosures are required

Weight of non-metallic enclosures is 25% of the weight of steel enclosures and can use for similar applications where non-metallic enclosures are preferred. Non-metallic enclosures are having good insulation properties and light weight and give advantages over steel enclosures in some applications.

Plastic Enclosure - with Stainless Steel Hinge & Latch - TJ series - Grey Door & Clear Door comes with stainless steel hinge & stainless steel latch and available in grey solid door or transparent door

Hinge + Latch Type		Dimension (mm)		Mounting Plate		Installation size (mm)	
Grey door	Clear door	W X H X D	D1 + D2	Plastic	Metal	W3	H3
TG-AG-0712H	TG-AT-0712H	75 X 125 X 75	50 + 25	TJ-0712P	TJ-0712	56	107
TG-AG-0712-1H	TG-AT-0712-1H	75 X 125 X 100	50 + 50	TJ-0712P	TJ-0712P	56	107
TG-AG-0811H	TG-AT-0811H	80 X 110 X 75	50 + 25	TJ-0811P	TJ-0811P	62	92
TG-AG-0811-1H	TG-AT-0811-1H	80 X 110 X 85	50 + 35	TJ-0811P	TJ-0811P	62	92
TG-AG-0811-2H	TG-AT-0811-2H	80 X 110 X 100	80 + 20	TJ-0811P	TJ-0811P	62	92
TG-AG-0811-3H	TG-AT-0811-3H	80 X 110 X 115	80 + 35	TJ-0811P	TJ-0811P	62	92
TG-AG-0813H	TG-AT-0813H	80 X 130 X 70	50 + 20	TJ-0813P	TJ-0813P	62	112
TG-AG-0813-1H	TG-AT-0813-1H	80 X 130 X 85	50 + 35	TJ-0813P	TJ-0813P	62	112
TG-AG-0818H	TG-AT-0818H	80 X 180 X 70	50 + 20	TJ-0818P	TJ-0818P	62	162
TG-AG-0818-1H	TG-AT-0818-1H	80 X 180 X 85	50 + 35	TJ-0818P	TJ-0818P	62	162
TG-AG-0822H	TG-AT-0822H	80 X 220 X 70	50 + 20	TJ-0822P	TJ-0822P	62	202
TG-AG-0825H	TG-AT-0825H	80 X 250 X 70	50 + 20	TJ-0825P	TJ-0825P	62	232
TG-AG-0825-1H	TG-AT-0825-1H	80 X 250 X 85	50 + 35	TJ-0825P	TJ-0825P	62	232
TG-AG-0825-2H	TG-AT-0825-2H	80 X 250 X 100	50 + 50	TJ-0825P	TJ-0825P	62	232
TG-AG-1010H	TG-AT-1010H	100 X 100 X 75	55 + 20	TJ-1010P	TJ-1010P	82	82
TG-AG-1010-1H	TG-AT-1010-1H	100 X 100 X 75	80 + 20	TJ-1010P	TJ-1010P	82	82
TG-AG-1118H	TG-AT-1118H	110 X 180 X 90	70 + 20	TJ-1118P	TJ-1118P	95	165
TG-AG-1118-1H	TG-AT-1118-1H	110 X 180 X 105	70 + 35	TJ-1118P	TJ-1118P	95	165
TG-AG-1212-5H	TG-AT-1212-5H	125 X 125 X 75	55 + 20	TJ-1212P	TJ-1212P	105	105
TG-AG-1212H	TG-AT-1212H	125 X 125 X 100	80 + 20	TJ-1212P	TJ-1212P	105	105
TG-AG-1216H	TG-AT-1216H	120 X 160 X 90	70 + 20	TJ-1216P	TJ-1216P	102	142
TG-AG-1217H	TG-AT-1217H	125 X 175 X 75	50 + 25	TJ-1217P	TJ-1217P	105	156
TG-AG-1217-1H	TG-AT-1217-1H	125 X 175 X 100	50 + 50	TJ-1217P	TJ-1217P	105	156
TG-AG-1217-2H	TG-AT-1217-2H	125 X 175 X 110	75 + 25	TJ-1217P	TJ-1217P	109	156
TG-AG-1217-3H	TG-AT-1217-3H	125 X 175 X 135	85 + 50	TJ-1217P	TJ-1217P	109	156
TG-AG-1220H	TG-AT-1220H	200 X 120 X 75	60 + 15	TJ-1220P	TJ-1220P	102	182
TG-AG-1222H	TG-AT-1222H	220 X 120 X 85	67 + 20	TJ-1222P	TJ-1222P	100	200
TG-AG-1417H	TG-AT-1417H	140 X 170 X 95	75 + 20	TJ-1417P	TJ-1417P	122	152
TG-AG-1423H	TG-AT-1423H	140 X 230 X 90	75 + 20	TJ-1423P	TJ-1423P	122	211
TG-AG-1520-5H	TG-AT-1520-5H	150 X 200 X 75	55 + 25	TJ-1520P	TJ-1520P	132	182
TG-AG-1520H	TG-AT-1520-H	150 X 200 X 100	80 + 20	TJ-1520P	TJ-1520P	132	182
TG-AG-1520-1H	TG-AT-1520-1H	150 X 200 X 130	80 + 50	TJ-1520P	TJ-1520P	132	182
TG-AG-1520-2H	TG-AT-1520-2H	150 X 200 X 130	110 + 20	TJ-1520P	TJ-1520P	132	182
TG-AG-1520-3H	TG-AT-1520-3H	150 X 200 X 160	110 + 50	TJ-1520P	TJ-1520P	132	182
TG-AG-1525H	TG-AT-1525H	150 X 250 X 100	80 + 20	TJ-1525P	TJ-1525P	132	232
TG-AG-1525-1H	TG-AT-1525-1H	150 X 250 X 130	80 + 50	TJ-1525P	TJ-1525P	132	232
TG-AG-1525-2H	TG-AT-1525-2H	150 X 250 X 130	110 + 20	TJ-1525P	TJ-1525P	132	232
TG-AG-1525-3H	TG-AT-1525-3H	150 X 250 X 160	110 + 50	TJ-1525P	TJ-1525P	132	232
TG-AG-1717H	TG-AT-1717H	175 X 175 X 75	50 + 25	TJ-1717P	TJ-1717P	156	156
TG-AG-1717-1H	TG-AT-1717-1H	175 X 175 X 100	50 + 50	TJ-1717P	TJ-1717P	156	156
TG-AG-1717-2H	TG-AT-1717-2H	175 X 175 X 110	100 + 25	TJ-1717P	TJ-1717P	157	157
TG-AG-1717-3H	TG-AT-1717-3H	175 X 175 X 130	100 + 50	TJ-1717P	TJ-1717P	157	157
TG-AG-1725H	TG-AT-1725H	175 X 250 X 75	50 + 25	TJ-1725P	TJ-1725P	156	232
TG-AG-1725-1H	TG-AT-1725-1H	175 X 250 X 100	50 + 50	TJ-1725P	TJ-1725P	155	232
TG-AG-1825H	TG-AT-1825H	180 X 255 X 100	85 + 25	TJ-1825P	TJ-1825P	155	157
TG-AG-2020-5H	TG-AT-2020-5H	200 X 200 X 100	75 + 20	TJ-2020P	TJ-2020P	182	182
TG-AG-2020H	TG-AT-2020H	200 X 200 X 125	75 + 50	TJ-2020P	TJ-2020P	182	182
TG-AG-2020-1H	TG-AT-2020-1H	200 X 200 X 130	80 + 50	TJ-2020P	TJ-2020P	182	182
TG-AG-2020-2H	TG-AT-2020-2H	200 X 200 X 160	110 + 50	TJ-2020P	TJ-2020P	182	182
TG-AG-2025H	TG-AT-2025H	200 X 250 X 100	75 + 25	TJ-2025P	TJ-2025P	178	223
TG-AG-2030H	TG-AT-2030H	300 X 200 X 105	85 + 25	TJ-2030P	TJ-2030P	180	280

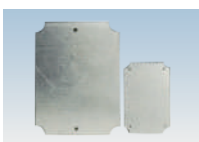
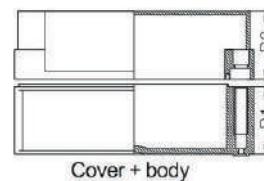
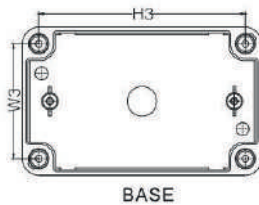
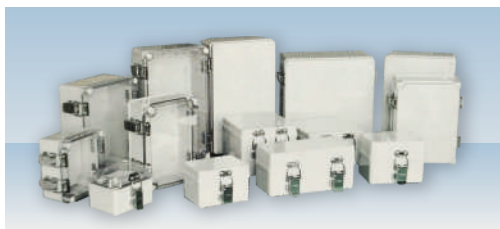

Steel mounting plate



Plastic mounting plate



Wall brackets for Plastic Box MODEL: WP - 01



Cap for screw MODEL: ZC - S10



Stainless steel hinge MODEL: HG-01



Stainless steel latch MODEL: LC-01

Hinges to be fixed on the longer side of enclosure. (If hinges on the shorter side needed is available as customized request)

**PLASTIC ENCLOSURE**

**Plastic Enclosure - with Stainless Steel Hinge & Latch - TJ series - Grey Door & Clear Door**

AIBOX non-metallic enclosures are corrosion proof and can use for many applications where non-metallic enclosures are required

Weight of non-metallic enclosures is 25% of the weight of steel enclosures and can use for similar applications where non-metallic enclosures are preferred. Non-metallic enclosures are having good insulation properties and light weight and give advantages over steel enclosures in some applications.

Plastic Enclosure - with Stainless Steel Hinge & Latch - TJ series - Grey Door & Clear Door comes with stainless steel hinge & stainless steel latch and available in grey solid door or transparent door

Hinge + Latch Type		Dimension (mm)		Mounting Plate		Installation size (mm)	
Grey door	Clear door	W X H X XD	D1 + D2	Plastic	Metal	W3	H3
TJ-AG-2819H	TJ-AT-2819H	280 X 190 X 130	98 + 32	TJ-2819P	TJ-2819	255	165
TJ-AG-2819 - 1H	TJ-AT-2819 - 1H	280 X 190 X 180	98 + 82	TJ-2819P	TJ-2819	255	165
TJ-AG-2819 - 2H	TJ-AT-2819 - 2H	280 X 190 X 180	148 + 32	TJ-2819P	TJ-2819	255	165
TJ-AG-2819 - 3H	TJ-AT-2819 - 3H	280 X 190 X 230	148 + 82	TJ-2819P	TJ-2819	255	165
TJ-AG-2828H	TJ-AT-2828H	280 X 280 X 130	98 + 32	TJ-2828P	TJ-2828	255	255
TJ-AG-2828 - 1H	TJ-AT-2828 - 1H	280 X 280 X 180	98 + 81	TJ-2828P	TJ-2828	255	255
TJ-AG-2828 - 2H	TJ-AT-2828 - 2H	280 X 280 X 180	148 + 32	TJ-2828P	TJ-2828	255	255
TJ-AG-2828 - 3H	TJ-AT-2828 - 3H	280 X 280 X 230	148 + 81	TJ-2828P	TJ-2828	255	255
TJ-AG-3428H	TJ-AT-3428H	340 X 280 X 130	98 + 32	TJ-3428P	TJ-3428	315	255
TJ-AG-3428 - 1H	TJ-AT-3428 - 1H	340 X 280 X 180	98 + 81	TJ-3428P	TJ-3428	355	355
TJ-AG-3819 - 5H	TJ-AT-3819 - 5H	380 X 190 X 100	69+ 30	TJ-3819P	TJ-3819	355	165
TJ-AG-3819H	TJ-AT-3819H	380 X 190 X 130	98 + 30	TJ-3819P	TJ-3819	355	165
TJ-AG-3819 - 1H	TJ-AT-3819 - 1H	380 X 190 X 180	148 + 30	TJ-3819P	TJ-3819	355	165
TJ-AG-3828H	TJ-AT-3828H	380 X 280 X 130	98 + 32	TJ-3828P	TJ-3828	355	255
TJ-AG-3828 - 1H	TJ-AT-3828 - 1H	380 X 280 X 180	98+ 82	TJ-3828P	TJ-3828	355	255
TJ-AG-3828 - 2H	TJ-AT-3828 - 2H	380 X 280 X 180	148 + 32	TJ-3828P	TJ-3828	355	255
TJ-AG-3828 - 3H	TJ-AT-3828 - 3H	380 X 280 X 230	148 + 82	TJ-3828P	TJ-3828	355	255
TJ-AG-2856H	TJ-AT-2856H	280 X 560X 130	98 + 32	TJ-2828P x 2	TJ-2856	540	255
TJ-AG-3856H	TJ-AT-3856H	380 X 560X 180	148 + 32	TJ-3828P x 2	TJ-3856	534	354

Hinges to be fixed on the longer side of enclosure. (If hinges on the shorter side needed is available as customized request)

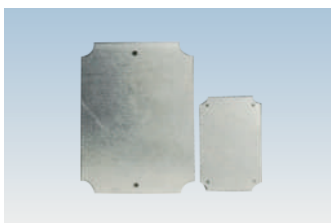
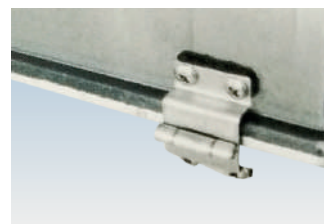
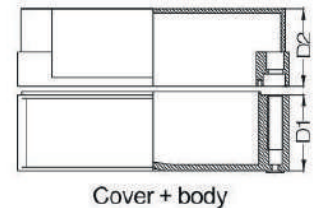
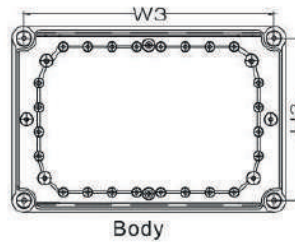

Steel mounting plate

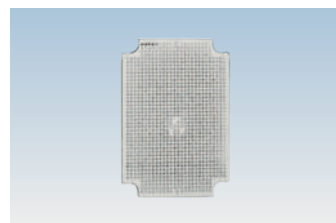

Plastic mounting plate



Wall brackets for Plastic Box  
MODEL: WP - 02



Door hinge fixing piece  
MODEL: LC - S11



Fixing bolts  
MODEL: LC-S12



Cap for screw  
MODEL: ZC - S10



Stainless steel hinge  
MODEL: HG-02



Stainless steel latch  
MODEL: LC-02

**PLASTIC ENCLOSURE**

**Plastic Enclosure - with Stainless Steel Hinge & Latch - TE series - Grey Door & Clear Door**

AIBOX non-metallic enclosures are corrosion proof and can use for many applications where non-metallic enclosures are required

Weight of non-metallic enclosures is 25% of the weight of steel enclosures and can use for similar applications where non-metallic enclosures are preferred. Non-metallic enclosures are having good insulation properties and light weight and give advantages over steel enclosures in some applications.

Plastic Enclosure - with Stainless Steel Hinge & Latch – TE series - Grey Door & Clear Door comes with stainless steel hinge & stainless steel latch and available in grey solid door or transparent door

The products prevent electromagnetic interference (EMI) and prevent substances of the static electricity,

Temperature range : -40°C to 120°C  
 ABS : Acrulonitrile Butadiene styrene  
 PC: Poly Carbonate

Plastic latch + hinge type		Dimension (mm)		Mounting Plate		Installation size (mm)	
Grey door	Clear door	W X H X D	D1 + D2	Plastic	Metal	W4	H4
TE-AG-1015	TE-AT-1015	100 X 150 X 70	50 + 20	TJ-1015P	TJ-1015	100	-
TE-AG-1020	TE-AT-1020	100 X 200 X 70	50 + 20	TJ-1020P	TJ-1020	150	-
TE-AG-1126-S	TE-AT-1126-S	110 X 260 X 75	55 + 20	-	TJ-1126	200	40
TE-AG-1126	TE-AT-1126	110 X 260 X 110	80 + 30	-	TJ-1126	200	40
TE-AG-1315	TE-AT-1315	135 X 155 X 80	60 + 20	-	TJ-1315	100	100
TE-AG-1318-S	TE-AT-1318-S	135 X 185 X 80	60 + 20	-	TJ-1318	130	100
TE-AG-1318	TE-AT-1318	135 X 185 X 110	90 + 20	-	TJ-1318	130	100
TE-AG-1515	TE-AT-1515	150 X 150 X 90	70 + 20	TJ-1515P	TJ-1515	100	100
TE-AG-1722	TE-AT-1722	170 X 220 X 110	80 + 30	TJ-1722P	TJ-1722	161	-
TE-AG-1727	TE-AT-1727	170 X 270 X 110	80 + 30	-	TJ-1727	180	100
TE-AG-1929	TE-AT-1929	190 X 290 X 140	110 + 30	TJ-1929P	TJ-1929	210	120
TE-AG-2530	TE-AT-2530	250 X 300 X 150	112 + 38	TJ-2530P	TJ-2530	230	180
TE-AG-2530-1	TE-AT-2530-1	250 X 300 X 180	140 + 38	TJ-2530P	TJ-2530	230	180
TE-AG-2535-1	TE-AT-2535-1	250 X 350 X 150	110 + 38	TJ-2535P	TJ-2535	275	175
TE-AG-2535	TE-AT-2535	250 X 350 X 180	142 + 38	TJ-2535P	TJ-2535	275	175
TE-AG-2919	TE-AT-2919	290 X 190 X 140	110 + 31	TJ-2919P	TJ-2919	120	210
TE-AG-2939	TE-AT-2939	290 X 390 X 160	132 + 28	TJ-2939P	TJ-2939	316	214
TE-AG-3030-S	TE-AT-3030-S	300 X 300 X 130	100 + 30	TJ-3030P	TJ-3030B	251	251
TE-AG-3030-A	TE-AT-3030-A	300 X 300 X 180	150 + 30	TJ-3030P	TJ-3030B	251	251
TE-AG-3546	TE-AT-3546	350 X 465 X 160	130 + 31	TJ-3546P	TJ-3546	410	296
TE-AG-3546-1	TE-AT-3546-1	350 X 465 X 200	170 + 31	TJ-3546P	TJ-3546	410	296
TE-AG-2020	TE-AT-2020	200 X 200 X 150	120 + 30	-	TJ-2020	150	180
TE-AG-2939-1	TE-AT-2939-1	290 X 390 X 200	170 + 30	TJ-2939P-1P	TJ-2939-1	214	316

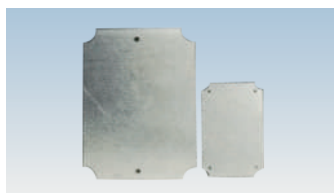
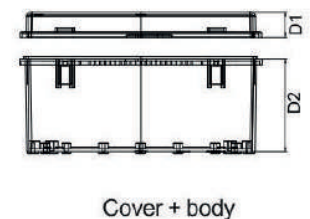
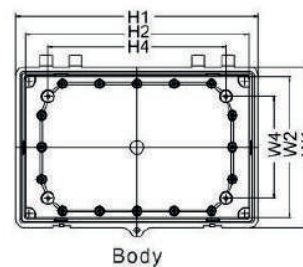

Steel mounting plate



Plastic mounting plate



Wall brackets for Plastic Box  
MODEL: WP - 02



Fixed with inner plate  
for box TE1722, TE 1929, TE2939, TE3546



Inner door hinge fixing  
MODEL: LC -S11



Fixing bolts for inner plate  
MODEL: LC-S12



Close with lead sealing



Closed with lock



**PLASTIC ENCLOSURE**

**Plastic Enclosure - Corner Hinge & Plastic Screw - TJ series - Grey Door & Clear Door**

Plastic Enclosure - Corner Hinge & Plastic Screw - TJ series - Grey Door & Clear Door comes with corner hinge & plastic screws and available in grey solid door or transparent door

Hinge + Screw type		Dimension (mm)		Mounting Plate		Installation size (mm)	
Grey door	Clear door	W X H X D	D1 + D2	Plastic	Metal	W3	H3
TJ-AG-2819L	TJ-AT-2819L	280 X 190 X 130	100 + 30	TJ-2819P	TJ-2819	255	165
TJ-AG-2819 - 1L	TJ-AT-2819 - 1L	280 X 190 X 180	100 + 80	TJ-2819P	TJ-2819	255	165
TJ-AG-2819 - 2L	TJ-AT-2819 - 2L	280 X 190 X 180	150 + 30	TJ-2819P	TJ-2819	255	165
TJ-AG-2819 - 3L	TJ-AT-2819 - 3L	280 X 190 X 230	150 + 80	TJ-2819P	TJ-2819	255	165
TJ-AG-2828L	TJ-AT-2828L	280 X 280 X 130	100 + 30	TJ-2828P	TJ-2828	255	255
TJ-AG-2828 - 1L	TJ-AT-2828 - 1L	280 X 280 X 180	100 + 80	TJ-2828P	TJ-2828	255	255
TJ-AG-2828 - 2L	TJ-AT-2828 - 2L	280 X 280 X 180	150 + 30	TJ-2828P	TJ-2828	255	255
TJ-AG-2828 - 3L	TJ-AT-2828 - 3L	280 X 280 X 230	150 + 80	TJ-2828P	TJ-2828	255	255
TJ-AG-3428L	TJ-AT-3428L	340 X 280 X 130	100 + 30	TJ-3428P	TJ-3428	315	255
TJ-AG-3428 - 1L	TJ-AT-3428 - 1L	340 X 280 X 180	100 + 80	TJ-3428P	TJ-3428	355	355
TJ-AG-3819 - 5L	TJ-AT-3819 - 5L	380 X 190 X 100	70 + 30	TJ-3819P	TJ-3819	355	165
TJ-AG-3819L	TJ-AT-3819L	380 X 190 X 130	100 + 30	TJ-3819P	TJ-3819	355	165
TJ-AG-3819 - 1L	TJ-AT-3819 - 1L	380 X 190 X 180	150 + 30	TJ-3819P	TJ-3819	355	165
TJ-AG-3828L	TJ-AT-3828L	380 X 280 X 130	100 + 30	TJ-3828P	TJ-3828	355	255
TJ-AG-3828 - 1L	TJ-AT-3828 - 1L	380 X 280 X 180	100 + 80	TJ-3828P	TJ-3828	355	255
TJ-AG-3828 - 2L	TJ-AT-3828 - 2L	380 X 280 X 180	150 + 30	TJ-3828P	TJ-3828	355	255
TJ-AG-3828 - 3L	TJ-AT-3828 - 3L	380 X 280 X 230	150 + 80	TJ-3828P	TJ-3828	355	255
TJ-AG-2856L	TJ-AT-2856L	280 X 560 X 130	100 + 30	TJ-2828PX2	TJ-2856	540	255
TJ-AG-3856L	TJ-AT-3856L	380 X 560 X 180	150 + 30	TJ-3828PX2	TJ-3856	534	354

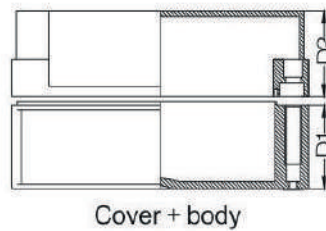
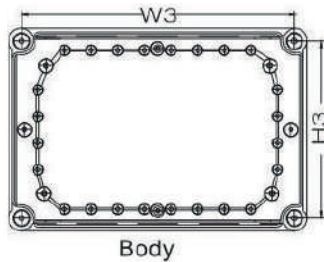

corner hinge, open at 180° degree



corner hinge, open at 180° degree

**Plastic Enclosure - Angled cover - Plastic Screw (Black) - PIS series - Grey Door & Clear Door**

Plastic Enclosure - Angled cover - Plastic Screw (Black) - PIS series - Grey Door & Clear Door comes with black plastic screws and available in grey solid door or transparent door

Angled cover for special applications

Screw type		Dimension (mm)		Mounting Plate		Installation size (mm)	
Grey door	Clear door	W X H X D	D1 + D2	Plastic	Metal	W3	H3
TJ-AG-2819 X	TJ-AT-2819 X	280 X 190 X 150	100 + 50	TJ-2819P	TJ-2819	255	165
TJ-AG-2819 - 1X	TJ-AT-2819 - 1X	280 X 190 X 200	150 + 50	TJ-2819P	TJ-2819	255	165
TJ-AG-3819 - X	TJ-AT-3819 - X	380 X 190 X 150	100 + 50	TJ-3819P	TJ-3819	355	165
TJ-AG-3819 - 1X	TJ-AT-3819 - 1X	380 X 190 X 200	150 + 50	TJ-3819P	TJ-3819	355	165

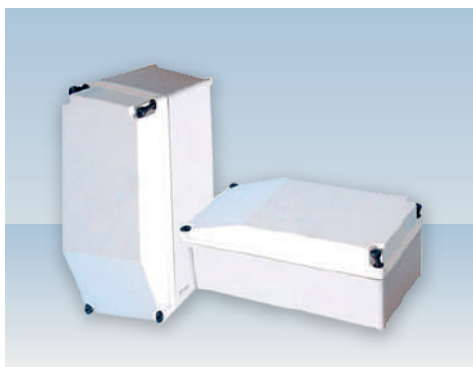

black screw



black screw, open at 180° degree



back view



Portable industrial socket plastic box

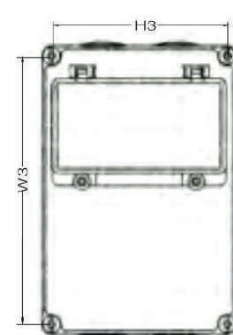

## Polyester Enclosures



**POLYESTER ENCLOSURES**

**Polyester enclosures - with Door - TIP series - Gray Door & Glass Door**

AIBOX non-metallic enclosures are corrosion proof and can use for many applications where non-metallic enclosures are required

Weight of non-metallic enclosures is 25% of the weight of steel enclosures and can use for similar applications where non-metallic enclosures are preferred. Non-metallic enclosures are having good insulation properties and light weight and give advantages over steel enclosures in some applications.

Polyester enclosures - with Door - TIP series - Gray Door & Glass Door comes with solid door or glass door. Inner door is optional.

The composition of polyesters contains min 30% fiber glass. it makes high ruggedness and mechanical stiffness, Polyester enclosures have high strength near to metal enclosure and weight is 33% of metal enclosures. Polyester enclosures are easy to machining and light weight

Material: Fiberglass/ SMC, self-extinguishable or UV material are on request

- Polyester enclosures includes;
- Door with locks
- Wall mount brackets 4pcs/set.
- Mounting plate optional.
- Door hinges allows more than 180 degrees opening.
- Protection degree: IP65

Polyester box (fiber glass box, GRP box)				
Model		Dimension (mm)		
Grey door	Glass door	W	H	D
TIP - 325	TX - 325	250	300	140
TIP - 43	TX - 43	300	400	200
TIP - 44	TX - 44	400	400	200
TIP - 54	TX - 54	400	500	200
TIP - 64	TX - 64	400	600	230
TIP - 65	TX - 65	500	600	230
TIP - 86	TX - 86	600	800	300

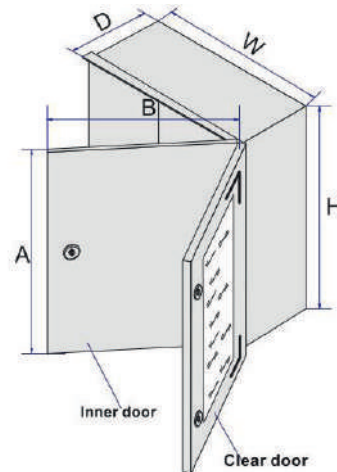

Polyester enclosure single door



Polyester enclosure with glass door



**POLYESTER ENCLOSURES**

**Mounting plate - for Polyester Enclosures - Polyester MP & Galvaized steel MP**

Polyester mounting plate			Galvanized mounting plate		
Model	Dimension (mm)		Model	Dimension (mm)	
	M	N		M	N
PP - 325	221	338	TI - 325	263	201
PP - 43	311	286	TI - 43	353	245
PP - 44	308	386	TI - 44	349	345
PP - 54	408	386	TI - 54	453	345
PP - 64	511	386	TI - 64	553	345
PP - 65	508	486	TI - 65	553	447
PP - 86	706	581	TI - 86	749	540

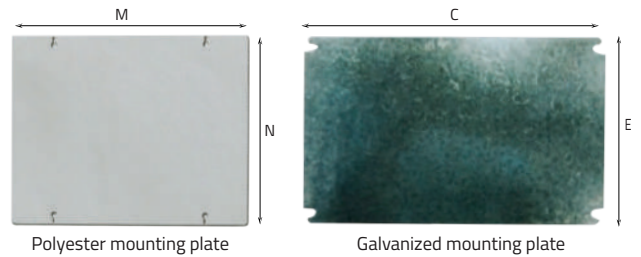

**Inner door - for Polyester Enclosures**

Model metal inner door	Dimension (mm) for box door			
	A	B	W	H
TP - 43	364	245	300	400
TP - 44	364	345	400	400
TP - 54	464	345	400	500
TP - 64	564	345	400	600
TP - 65	564	445	500	600
TP - 86	764	545	600	800



**DIN Rails Kit - for Polyester Enclosures**

Model	Door		No. of breakers	Breakers qty (PCS)	No. of rows
	W	H			
MDTT43	300	400	2 rows x 12P	24	2
MDTT44	400	400	2 rows x 18P	36	2
MDTT54	400	500	3 rows x 18P	54	3
MDTT64	400	600	4 rows x 18P	72	4
MDTT65	500	600	4 rows x 23P	92	4
MDTT86	600	800	5 rows x 29P	145	5



**Accessories - for Polyester Enclosures**

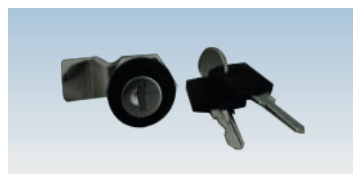

Key lock Model: MS705 -3E  
Package:1pc



Standard lock Model: MS-01  
Package:1pc



Wall mounting brackets Model: TXP-01  
Package:4pcs/set

**POLYESTER ENCLOSURES**

**Polyester Enclosures - with Screws - PSM Series - Grey Door**

Polyester Enclosures - with Screws - PSM Series - Grey Door comes with solid door

The composition of polyesters contains min 30% fiber glass. it makes high ruggedness and mechanical stiffness, Polyester enclosures have high strength near to metal enclosure and weight is 33% of metal enclosures. Polyester enclosures are easy to machining and light weight

The products prevent electromagnetic interference (EMI) and prevent substances of the static electricity,

Temperature range : -40°C to 120°C

Cabin: SMC (fiber glass)

Cover: SMC (fiber glass)

Screw Type	Dimension (mm)		Mounting Plate
	W X H X XD	D1 + D2	
Grey door			Metal
PSM - 0708	80 X 75 X 55	40 + 15	TJ - 0708
PSM - 0711	110 X 75 X 55	40 + 15	TJ - 0711
PSM - 1212	122 X 120 X 90	65 + 25	TJ - 1212
PSM - 1616	160 X 160 X 90	70 + 20	TJ - 1616
PSM - 1626	160 X 260 X 90	70 + 20	TJ - 1626
PSM - 2525	250 X 250 X 120	95 + 25	TJ - 2525
PSM - 2540	250 X 400 X 120	95 + 25	TJ - 2540

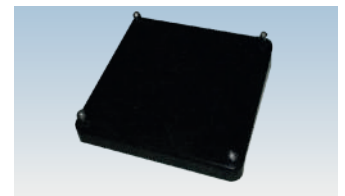
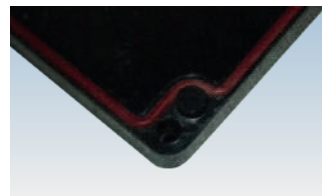
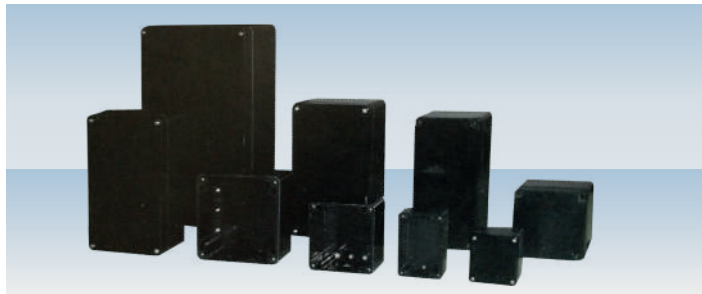
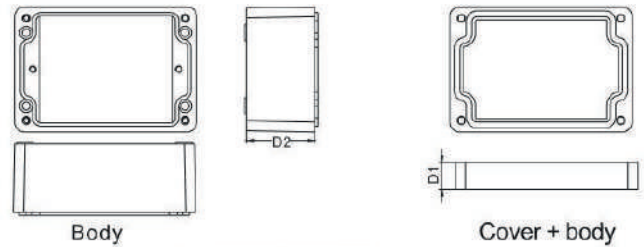

**Polyester Enclosures - with Screws - PSG & PST Series - Grey Door & Clear Door**

Polyester Enclosures - with Screws - PSG & PST Series - Grey Door & Clear Door comes with solid door & transparent door

The composition of polyesters contains min 30% fiber glass. it makes high ruggedness and mechanical stiffness, Polyester enclosures have high strength near to metal enclosure and weight is 33% of metal enclosures. Polyester enclosures are easy to machining and light weight

The products prevent electromagnetic interference (EMI) and prevent substances of the static electricity,

Temperature range : -40°C to 120°C

Cabin: SMC (fiber glass)

Cover: Polycarbonate

Screw type		Dimension (mm)		Mounting Plate	Installation size (mm)	
Grey door	Clear door	W X H X XD	D1 + D2		W3	H3
PSM - 2718	PST - 2718	270 X 180 X 170	125 + 45	TJ-2718	265	155
PSM - 3627	PSM - 3627	360 X 270 X 170	125 + 45	TJ-3627	355	245

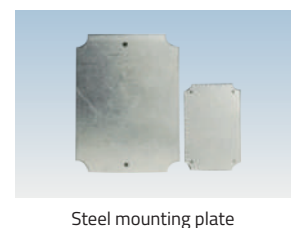
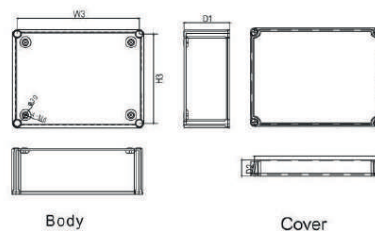

## GRP (Glass Reinforced Plastics ) Enclosures

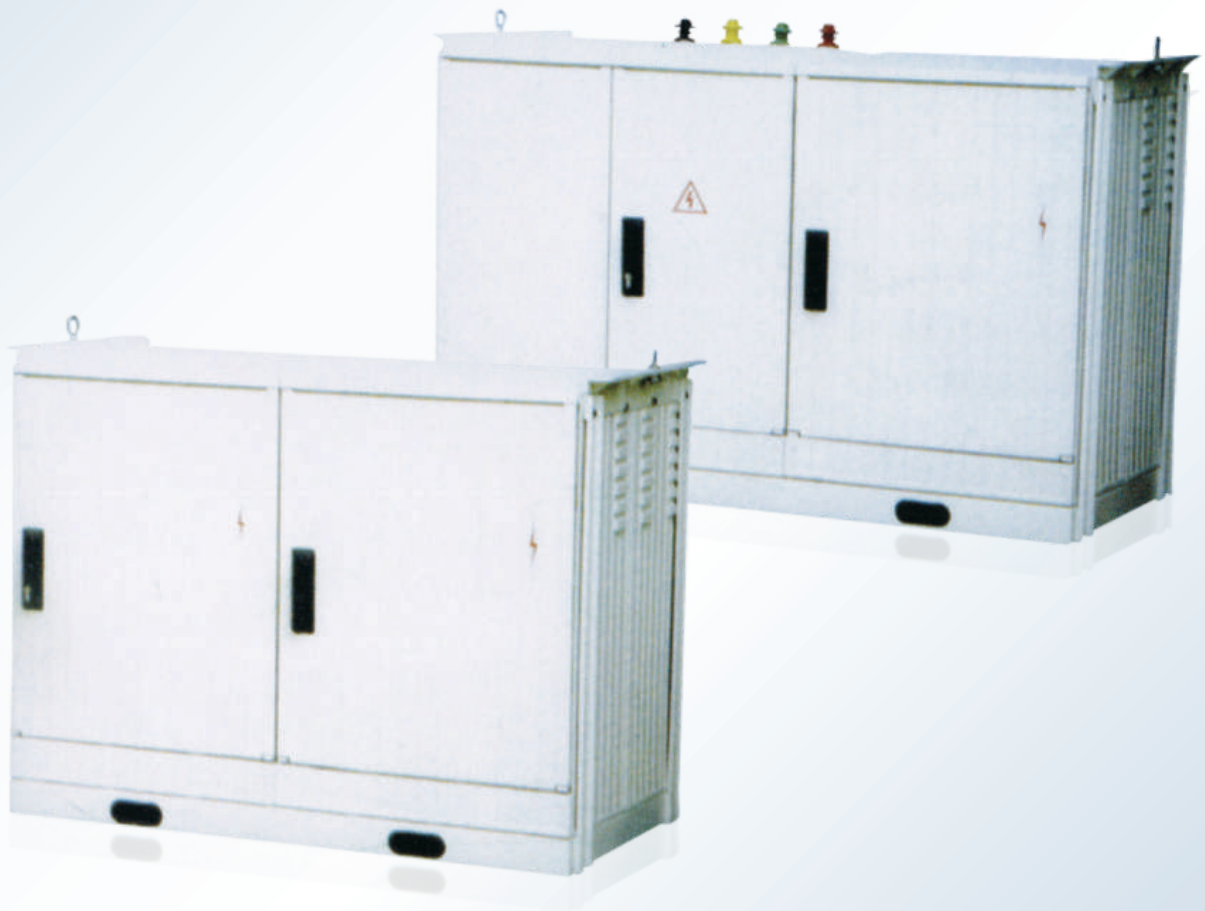

**GRP (GLASS REINFORCED PLASTICS) ENCLOSURES**

**GRP Enclosures - Free Standing**

GRP Enclosure part are made of high temperature pressure formed polymer composite materials (SMC).  
 GRP Enclosure is made of pressure formed parts of modular construction, to high precise dimensions and can assemble easier & faster.  
 Excellent insulation property. GRP Enclosure is a completely insulated and no need a body earth.  
 Excellent heat-shielding performance and specially design ventilation structure to prevent, condensation of frost inside the enclosure.  
 Excellent corrosion proof properties to withstand dilute acid, base, salt and rain corrosion

Excellent aging resistance with property adding substances to materials to withstand ultraviolet rays to make the enclosure more durable and for longer life.  
 Completely sealed structure and special protection design to make protection class up to IP54

Model	W X H X XD	Model	W X H X XD
PDB-SMC-608632	600 x 865 x 320	PDB-SMC-601232	600 x 1250 x 320
PDB-SMC-806532	800 x 650 x 320	PDB-SMC-801232	800 x 1250 x 320
PDB-SMC-108632	1000 x 865 x 320	PDB-SMC-101232	1000 x 1250 x 320
PDB-SMC-128632	1200 x 865 x 320	PDB-SMC-121232	1200 x 1250 x 320
PDB-SMC-601032	600 x 1015 x 320	PDB-SMC-801248	800 x 1250 x 485
PDB-SMC-801032	800 x 1015 x 320	PDB-SMC-101248	1000 x 1250 x 485
PDB-SMC-101032	1000 x 1015 x 320	PDB-SMC-601064	600 x 1065 x 640
PDB-SMC-121032	1200 x 1015 x 320	PDB-SMC-801064	800 x 1065 x 640
PDB-SMC-801048	800 x 1015 x 485	PDB-SMC-101064	1000 x 1065 x 640
PDB-SMC-101048	1000 x 1015 x 485	PDB-SMC-121064	1200 x 1065 x 640
PDB-SMC-601132	600 x 1100 x 320	PDB-SMC-141064	1400 x 1065 x 640
PDB-SMC-801132	800 x 1100 x 320	PDB-SMC-607060	600 x 700 x 600
PDB-SMC-101132	1000 x 1100 x 320	PDB-SMC-801350	800 x 1370 x 500
PDB-SMC-121132	1200 x 1100 x 320	PDB-SMC-121350	1200 x 1370 x 500
PDB-SMC-816497	810 x 640 x 970	PDB-SMC-126497	1200 x 640 x 970
PDB-SMC-966032	960 x 600 x 320	PDB-SMC-156497	1500 x 640 x 970
PDB-SMC-978164	970 x 810 x 640	PDB-SMC-176497	1700 x 640 x 970
PDB-SMC-116032	1140 x 600 x 320	PDB-SMC-196497	1900 x 640 x 970
PDB-SMC-126032	1200 x 600 x 320		



**Components List**

No.	Name	No.	Name
1	Rack plate	13	Door Lock Catch
2	Left Plate	14	Hinge Hitch
3	Right Plate	15	Lightning Symbol
4	Top Plate	16	Upper Sliding Part
5	Movable Plate	17	Under Sliding Part
6	Left Door Plate	18	Door Lock
7	Door Lock Catch	19	Door Lock Antislip Piece
8	Screw	20	Lock Bolt
9	Square Nut	21	Left Door Plate
10	Section Lock Catch	22	Back Plate Connecting Piece
11	Top Plate Screw	23	Base Right Plate
12	Pad	24	Base Front Back Plate

**Box Exploded diagram**

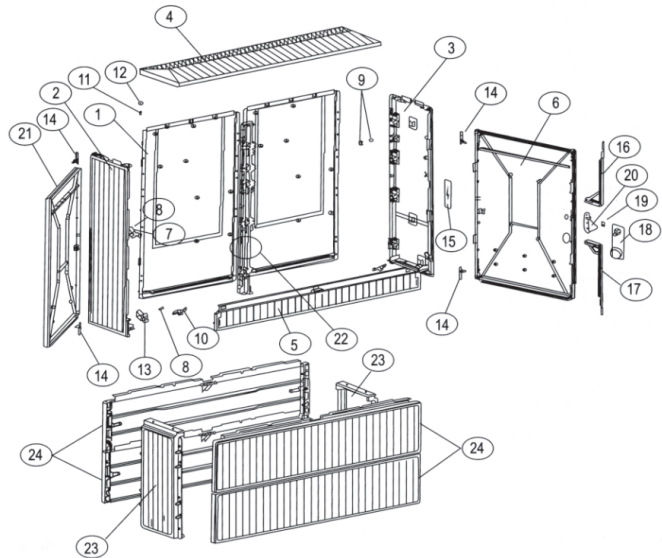

Sole distributor in Sri Lanka



**Cubik Engineering Co. (Pvt) Ltd**

No. 399/6, Nawala Road, Rajagiriya, Sri Lanka.

Tel : 2 86 10 10 (Auto Lines)

Fax : 2 86 40 40

E-mail : [sales@cubik.lk](mailto:sales@cubik.lk) / [info@cubik.lk](mailto:info@cubik.lk)

Web : [www.cubik.lk](http://www.cubik.lk)

**AIBOX<sup>TM</sup>**  
NON METALLIC ENCLOSURES

**AR CORPORATION LIMITED**

2318 Leighton Centre, 77 Leighton Road,  
Causeway Bay, Hong Kong.

Email : [info@aibox-enclosures.com](mailto:info@aibox-enclosures.com)

Website : [www.aibox-enclosures.com](http://www.aibox-enclosures.com)